



60W Constant Voltage + Constant Current LED Driver

HLG-60H series



Features

- Constant Voltage + Constant Current mode output
- Metal housing with class I design
- Built-in active PFC function
- Class 2 power unit
- IP67 / IP65 rating for indoor or outdoor installations
- Function options: output adjustable via potentiometer; 3 in 1 dimming; Timer dimming
- Typical lifetime > 62000 hours
- 7 years warranty

Applications

- LED street lighting
- LED high-bay lighting
- Parking space lighting
- LED fishing lamp
- LED greenhouse lighting
- Type “HL” for use in Class I , Division 2 hazardous (Classified) location.

Description

HLG-60H series is a 60W AC/DC LED driver featuring the dual mode constant voltage and constant current output. HLG-60H operates from 90 ~ 305VAC and offers models with different rated voltage ranging between 15V and 54V. Thanks to the high efficiency up to 90.5%, with the fanless design, the entire series is able to operate for -40°C ~ +80°C case temperature under free air convection. The design of metal housing and IP67/IP65 ingress protection level allows this series to fit both indoor and outdoor applications. HLG-60H is equipped with various function options, such as dimming methodologies, so as to provide the optimal design flexibility for LED lighting system.

Model Encoding

HLG - 60H - 42 A

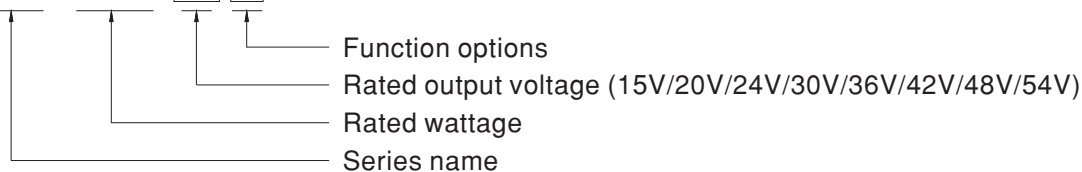

Type	IP Level	Function	Note
Blank	IP67	Io and Vo fixed	In Stock
A	IP65	Io and Vo adjustable through built-in potentiometer	In Stock
B	IP67	3 in 1 dimming function (1~10VDC, 10V PWM signal and resistance)	In Stock
D	IP67	Timer dimming function, contact MEAN WELL for details(safety pending).	By request



SPECIFICATION

MODEL	HLG-60H-15	HLG-60H-20	HLG-60H-24	HLG-60H-30	HLG-60H-36	HLG-60H-42	HLG-60H-48	HLG-60H-54		
OUTPUT	DC VOLTAGE	15V	20V	24V	30V	36V	42V	48V	54V	
	CONSTANT CURRENT REGION Note.4	9 ~ 15V	12 ~ 20V	14.4 ~ 24V	18 ~ 30V	21.6 ~ 36V	25.2 ~ 42V	28.8 ~ 48V	32.4 ~ 54V	
	RATED CURRENT	4A	3A	2.5A	2A	1.7A	1.45A	1.3A	1.15A	
	RATED POWER	60W	60W	60W	60W	61.2W	60.9W	62.4W	62.1W	
	RIPPLE & NOISE (max.) Note.2	150mVp-p	150mVp-p	150mVp-p	200mVp-p	200mVp-p	300mVp-p	300mVp-p	300mVp-p	
	VOLTAGE ADJ. RANGE	Adjustable for A-Type only (via built-in potentiometer)								
		13.5 ~ 17V	17 ~ 22V	22 ~ 27V	27 ~ 33V	33 ~ 40V	40 ~ 46V	44 ~ 53V	49 ~ 58V	
	CURRENT ADJ. RANGE	Adjustable for A-Type only (via built-in potentiometer)								
		2.4 ~ 4A	1.8 ~ 3A	1.5 ~ 2.5A	1.2 ~ 2A	1 ~ 1.7A	0.87 ~ 1.45A	0.78 ~ 1.3A	0.69 ~ 1.15A	
	VOLTAGE TOLERANCE Note.3	± 2.0%	± 1.0%	± 1.0%	± 1.0%	± 1.0%	± 1.0%	± 1.0%	± 1.0%	
	LINE REGULATION	± 0.5%	± 0.5%	± 0.5%	± 0.5%	± 0.5%	± 0.5%	± 0.5%	± 0.5%	
LOAD REGULATION	± 1.5%	± 1.0%	± 0.5%	± 0.5%	± 0.5%	± 0.5%	± 0.5%	± 0.5%		
SETUP, RISE TIME Note.6	500ms,80ms/115VAC 500ms,80ms/230VAC									
HOLD UP TIME (Typ.)	16ms / 115VAC, 230VAC									
INPUT	VOLTAGE RANGE Note.5	90 ~ 305VAC 127 ~ 431VDC (Please refer to "STATIC CHARACTERISTIC" section)								
	FREQUENCY RANGE	47 ~ 63Hz								
	POWER FACTOR (Typ.)	PF ≥ 0.98/115VAC, PF ≥ 0.95/230VAC, PF ≥ 0.92/277VAC @ full load (Please refer to "POWER FACTOR (PF) CHARACTERISTIC" section)								
	TOTAL HARMONIC DISTORTION	THD < 20% (@ load ≥ 60% / 115VAC, 230VAC; @ load ≥ 75% / 277VAC) (Please refer to "TOTAL HARMONIC DISTORTION (THD)" section)								
	EFFICIENCY (Typ.)	87.5%	89%	89.5%	90%	90%	90%	90.5%	90.5%	
	AC CURRENT (Typ.)	0.64A / 115VAC	0.32A / 230VAC	0.3A / 277VAC						
	INRUSH CURRENT (Typ.)	COLD START 55A (t _{width} =265μs measured at 50% I _{peak}) at 230VAC; Per NEMA 410								
	MAX. No. of PSUs on 16A CIRCUIT BREAKER	9 units (circuit breaker of type B) / 16 units (circuit breaker of type C) at 230VAC								
LEAKAGE CURRENT	< 0.75mA / 277VAC									
PROTECTION	OVER CURRENT Note.4	95 ~ 108% Constant current limiting, recovers automatically after fault condition is removed								
	SHORT CIRCUIT	Hiccup mode, recovers automatically after fault condition is removed								
	OVER VOLTAGE	18 ~ 24V	23 ~ 30V	28 ~ 35V	35 ~ 43V	41 ~ 49V	48 ~ 58V	54 ~ 65V	59 ~ 68V	
	OVER TEMPERATURE	Shut down o/p voltage, re-power on to recover								
ENVIRONMENT	WORKING TEMP.	T _{case} = -40 ~ +80°C (Please refer to "OUTPUT LOAD vs TEMPERATURE" section)								
	MAX. CASE TEMP.	T _{case} = +80°C								
	WORKING HUMIDITY	20 ~ 95% RH non-condensing								
	STORAGE TEMP., HUMIDITY	-40 ~ +80°C, 10 ~ 95% RH								
	TEMP. COEFFICIENT	± 0.03%/°C (0 ~ 60°C)								
VIBRATION	10 ~ 500Hz, 5G 12min./1cycle, period for 72min. each along X, Y, Z axes									
SAFETY & EMC	SAFETY STANDARDS Note.8	UL8750(type"HL"), CSA C22.2 No. 250.0-08 (except for 48V, 54V), TUV EN61347-1, EN61347-2-13 independent, IP65 or IP67 approved ; optional models for J61347-1, J61347-2-13 ; design refer to UL60950-1, TUV EN60950-1, EN60335-1								
	WITHSTAND VOLTAGE	I/P-O/P:3.75KVAC I/P-FG:2KVAC O/P-FG:1.5KVAC								
	ISOLATION RESISTANCE	I/P-O/P, I/P-FG, O/P-FG:100M Ohms / 500VDC / 25°C / 70% RH								
	EMC EMISSION Note.8	Compliance to EN55015, EN61000-3-2 Class C (@ load ≥ 60%) ; EN61000-3-3								
EMC IMMUNITY	Compliance to EN61000-4-2,3,4,5,6,8,11; EN61547, light industry level (surge immunity Line-Earth 4KV, Line-Line 2KV)									
OTHERS	MTBF	1132K hrs min. Telcordia SR-332 (Bellcore) ; 338K hrs min. MIL-HDBK-217F (25°C)								
	DIMENSION	171*61.5*36.8mm (L*W*H)								
	PACKING	0.73Kg; 20pcs/15.6Kg/0.9CUFT								
NOTE	<ol style="list-style-type: none"> All parameters NOT specially mentioned are measured at 230VAC input, rated current and 25°C of ambient temperature. Ripple & noise are measured at 20MHz of bandwidth by using a 12" twisted pair-wire terminated with a 0.1uf & 47uf parallel capacitor. Tolerance : includes set up tolerance, line regulation and load regulation. Please refer to "DRIVING METHODS OF LED MODULE". De-rating may be needed under low input voltages. Please refer to "STATIC CHARACTERISTIC" sections for details. Length of set up time is measured at first cold start. Turning ON/OFF the driver may lead to increase of the set up time. The driver is considered as a component that will be operated in combination with final equipment. Since EMC performance will be affected by the complete installation, the final equipment manufacturers must re-qualify EMC Directive on the complete installation again. The model certified for CCC(GB19510.14, GB19510.1, GB17743 and GB17625.1) is an optional model . Please contact MEAN WELL for details. To fulfill requirements of the latest ErP regulation for lighting fixtures, this LED driver can only be used behind a switch without permanently connected to the mains. This series meets the typical life expectancy of >62,000 hours of operation when T_{case}, particularly (T_c) point (or TMP, per DLC), is about 70°C or less. Please refer to the warranty statement on MEAN WELL's website at http://www.meanwell.com 									

■ BLOCK DIAGRAM

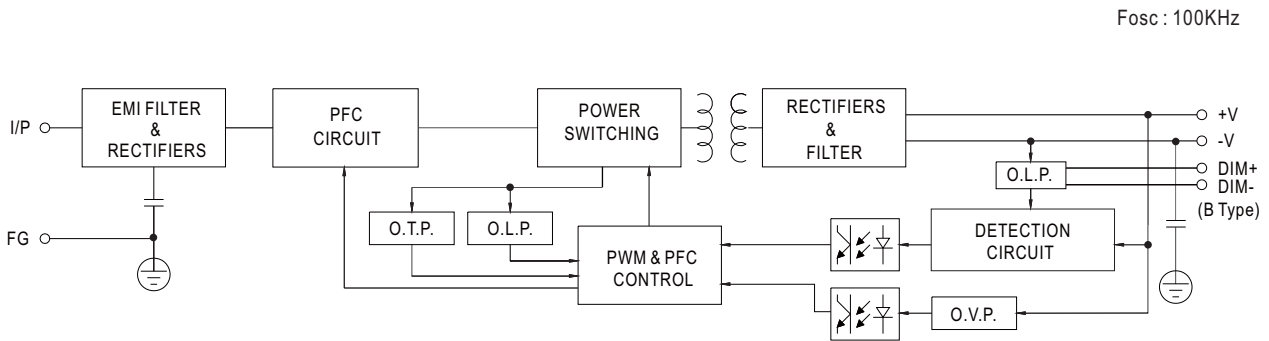

■ DRIVING METHODS OF LED MODULE

※ This series is able to work in either Constant Current mode (a direct drive way) or Constant Voltage mode (usually through additional DC/DC driver) to drive the LEDs.

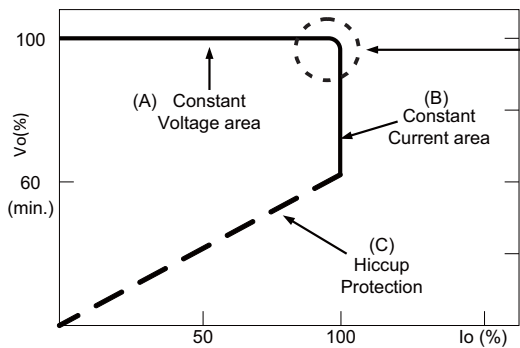

Typical output current normalized by rated current (%)

In the constant current region, the highest voltage at the output of the driver depends on the configuration of the end systems.

Should there be any compatibility issues, please contact MEAN WELL.

DIMMING OPERATION

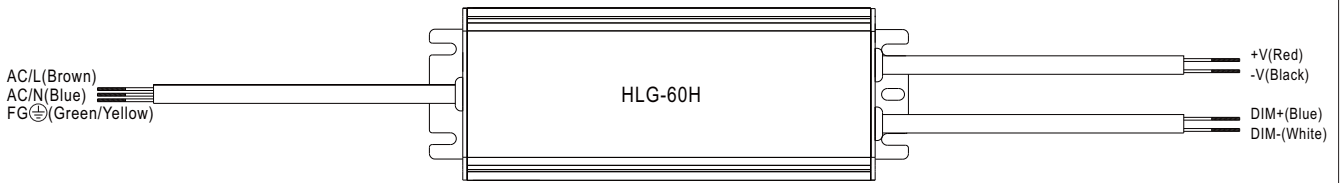

※ 3 in 1 dimming function (for B-Type)

- Output constant current level can be adjusted by applying one of the three methodologies between DIM+ and DIM-: 1 ~ 10VDC, or 10V PWM signal or resistance.
- Direct connecting to LEDs is suggested. It is not suitable to be used with additional drivers.
- Dimming source current from power supply: 100 μ A (typ.)

◎ Applying additive 1 ~ 10VDC

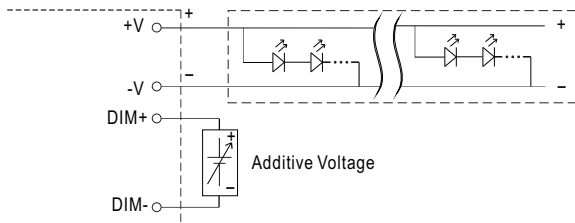

“DO NOT connect "DIM- to -V"”

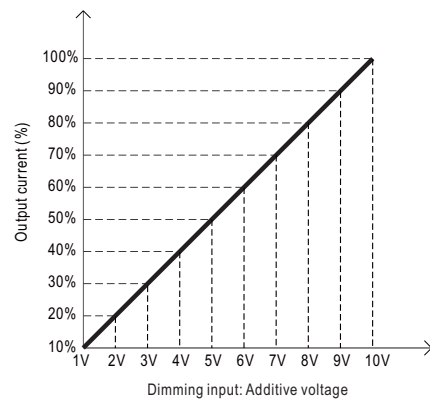

◎ Applying additive 10V PWM signal (frequency range 100Hz ~ 3KHz):

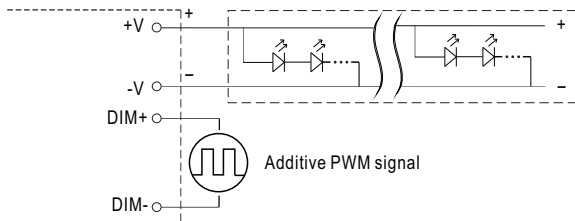

“DO NOT connect "DIM- to -V"”

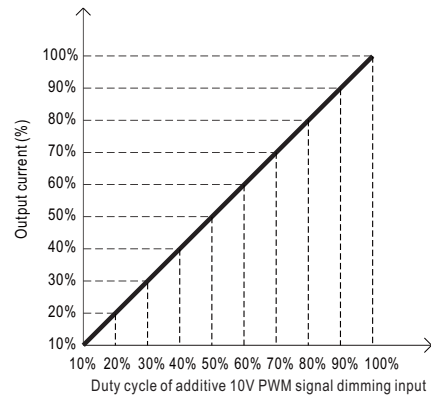

◎ Applying additive resistance:

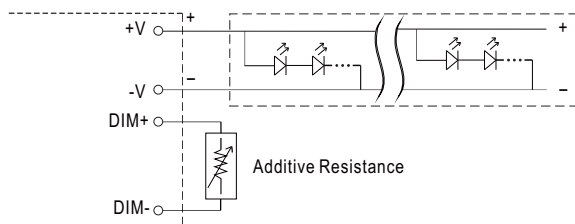

“DO NOT connect "DIM- to -V"”

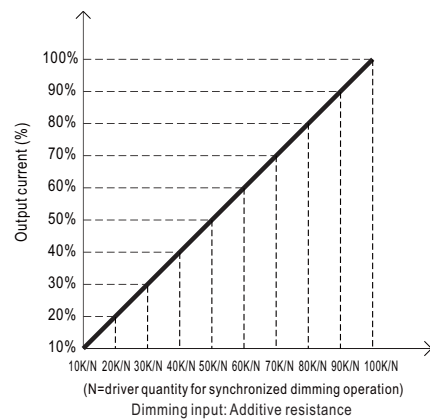

Note: In the case of turning the lighting fixture down to 0% brightness, please refer to the configuration as follow, or please contact MEAN WELL for other options.

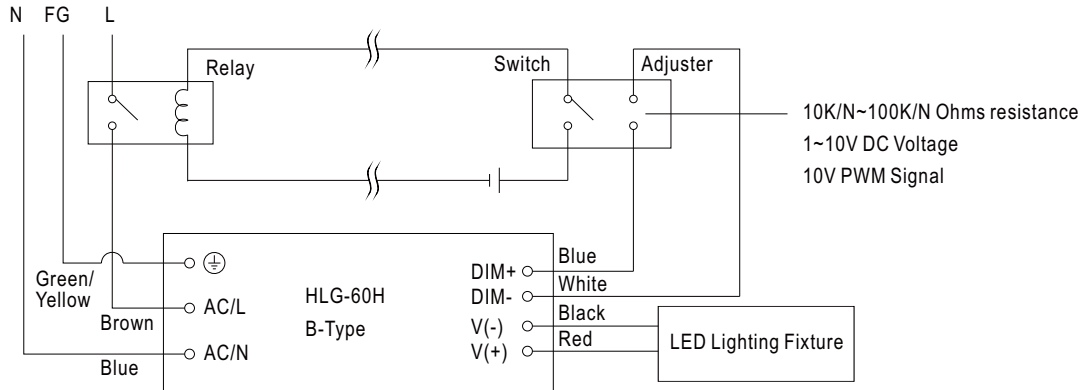

Using a switch and relay can turn ON/OFF the lighting fixture.

OUTPUT LOAD vs TEMPERATURE

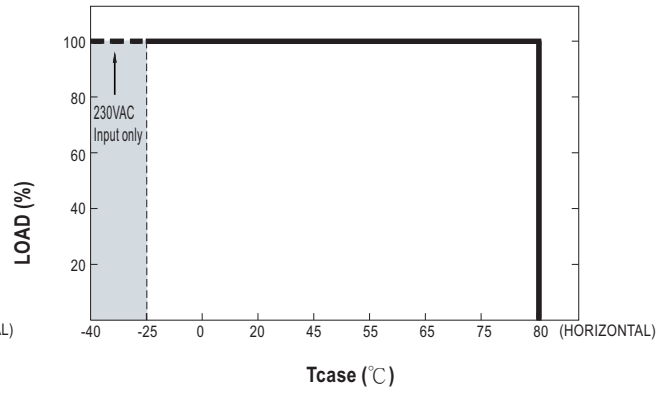
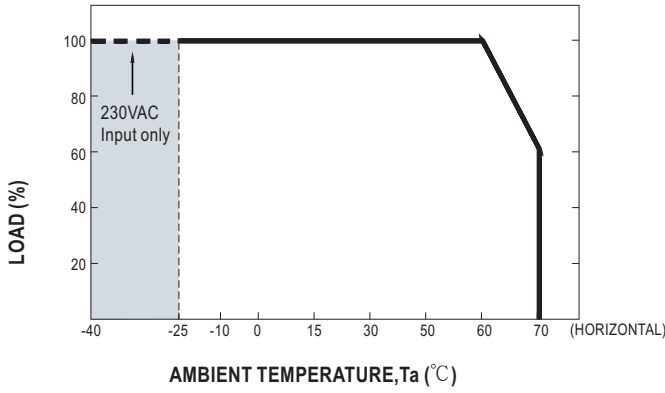

STATIC CHARACTERISTICS

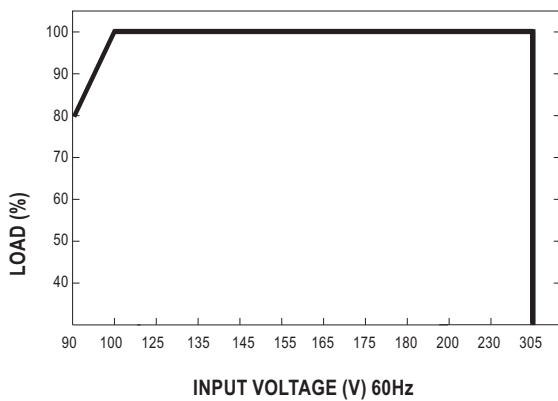

※ De-rating is needed under low input voltage.

POWER FACTOR(PF) CHARACTERISTIC

※ T_{case} at 70°C

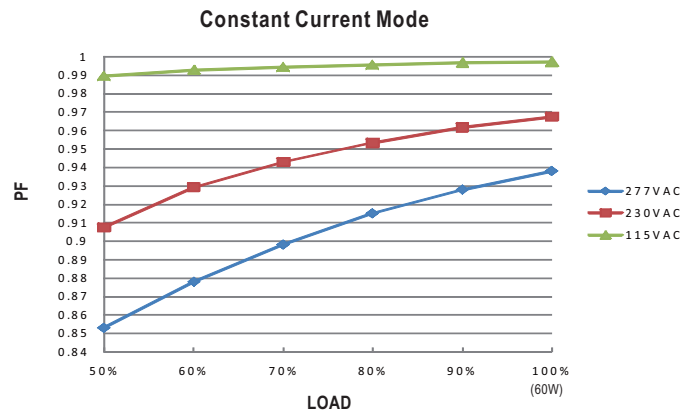

TOTAL HARMONIC DISTORTION (THD)

※ 48V Model, T_{case} at 70°C

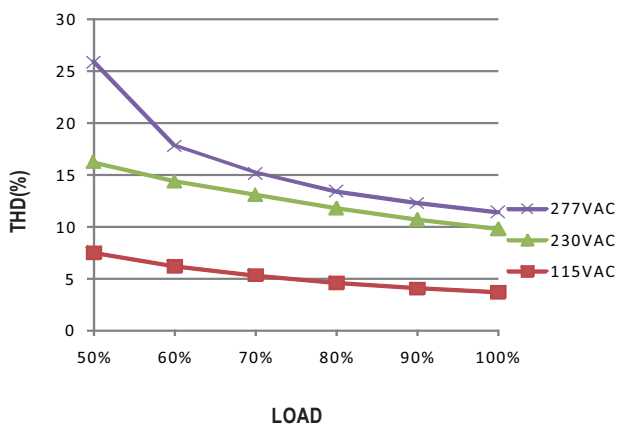

EFFICIENCY vs LOAD

HLG-60H series possess superior working efficiency that up to 90.5% can be reached in field applications.

※ 48V Model, T_{case} at 70°C

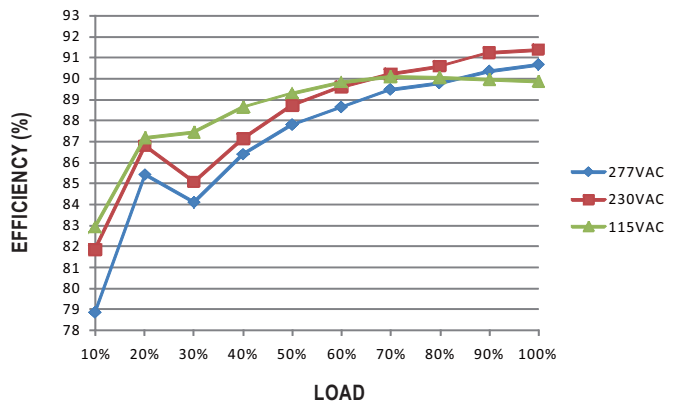



■ LIFETIME

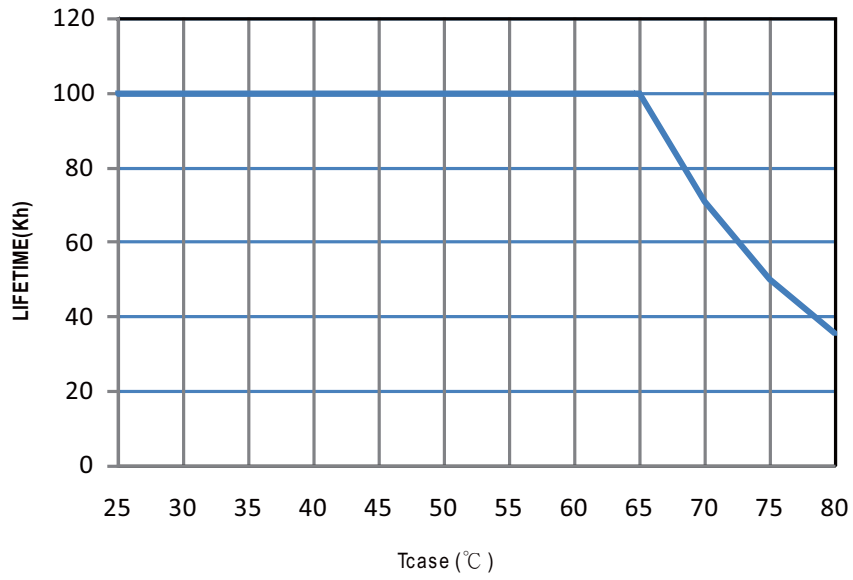

MECHANICAL SPECIFICATION

Case No.957B Unit:mm

※Blank/D-Type

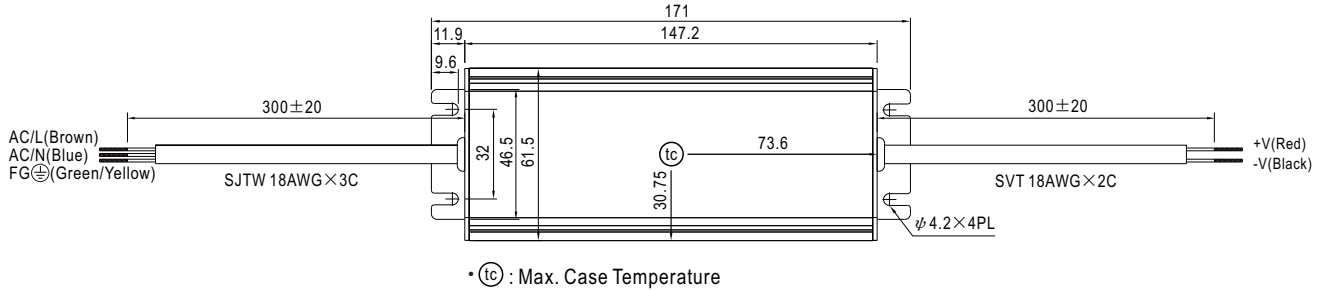

※A-Type

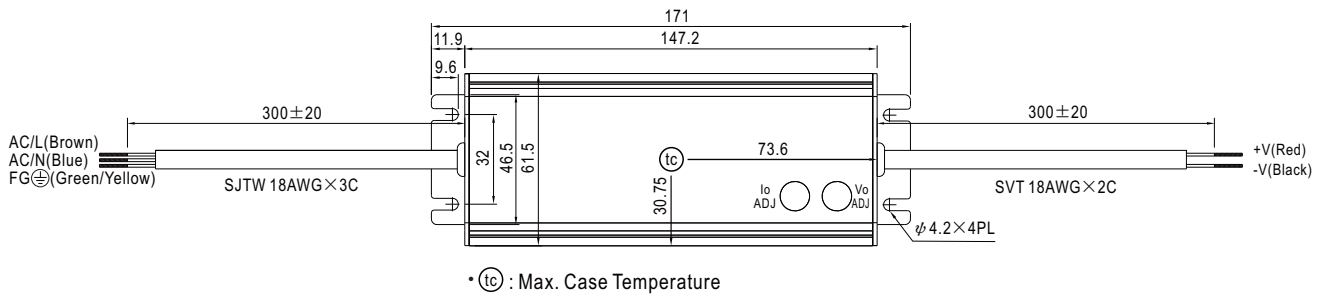

※B-Type

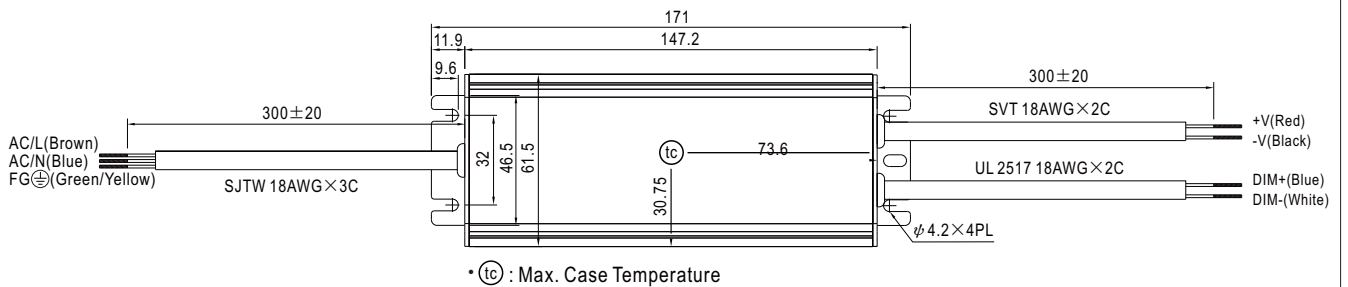

■ WATERPROOF CONNECTION

※ Waterproof connector

Waterproof connector can be assembled on the output cable of HLG-60H to operate in dry/wet/damp or outdoor environment.

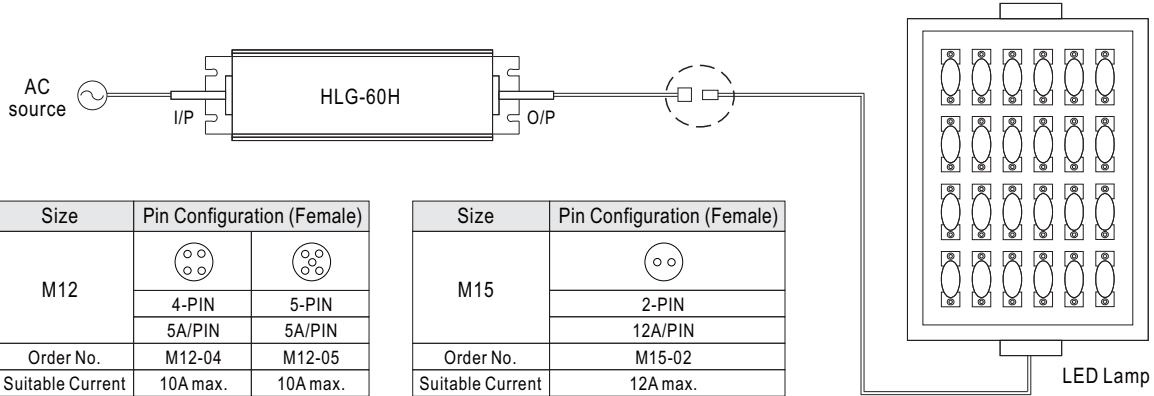

※ Cable Joiner

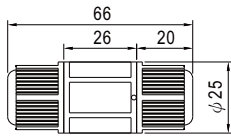

CJ04-1 suitable for 14AWG~16AWG
CJ04-2 suitable for 18AWG~22AWG



Up to four wires can be connected through this cable joiner by soldering or clamping by tools.

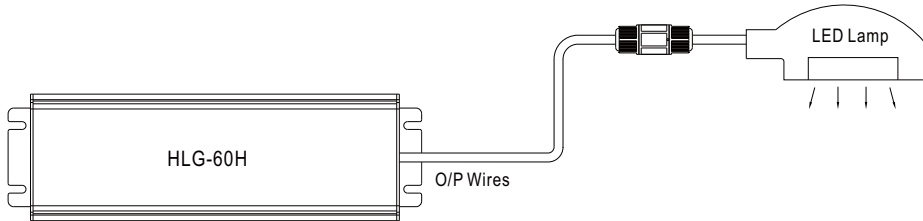
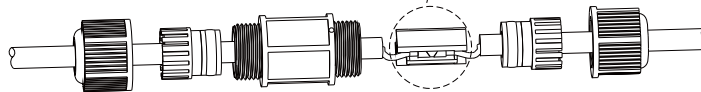

◎ CJ04 cable joiner can be purchased independently for user's own assembly.
MEAN WELL order No. : CJ04-1, CJ04-2.

■ INSTALLATION MANUAL

Please refer to : <http://www.meanwell.com/webnet/search/InstallationSearch.html>